

1. 3/4 x 3 1/4"

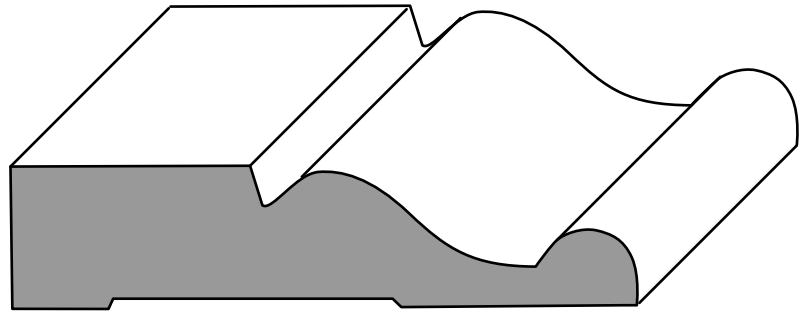

2. 3/4 x 3 1/4"

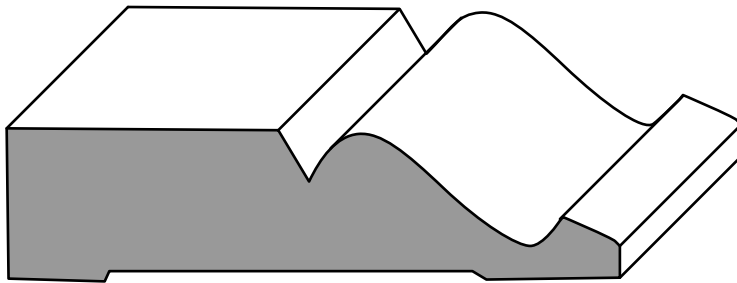

3. 3/4 x 3 1/4"

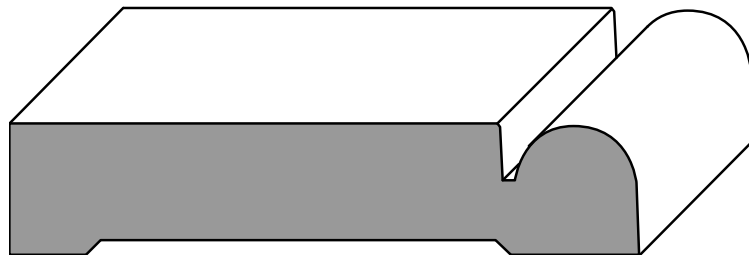

4. 3/4 x 3 1/4"

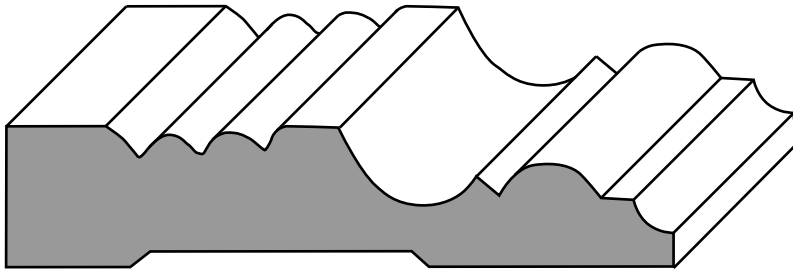

5. $3/4 \times 3\ 1/2$ "

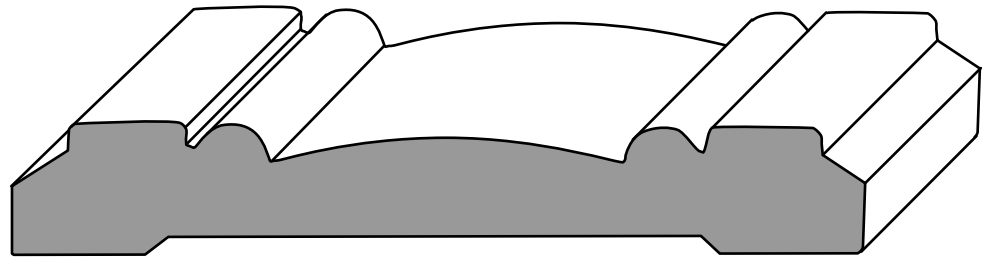

6. $11/16 \times 4\ 1/2$ "

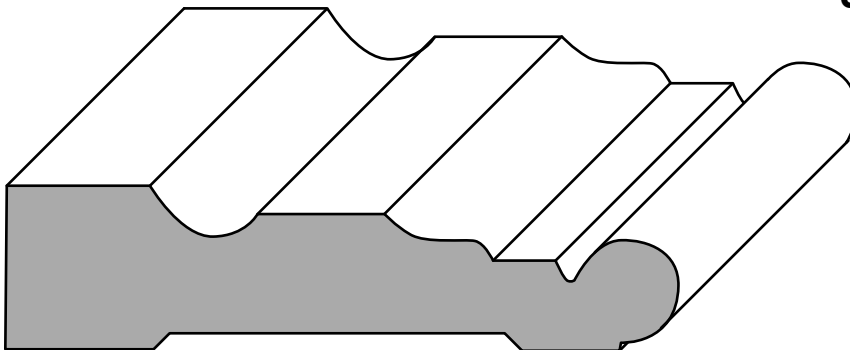

7. $7/8 \times 3\ 1/2$ "

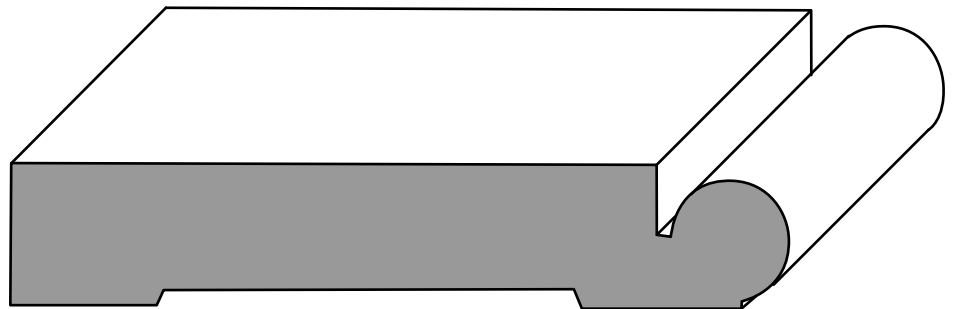

8. $3/4 \times 4$ "

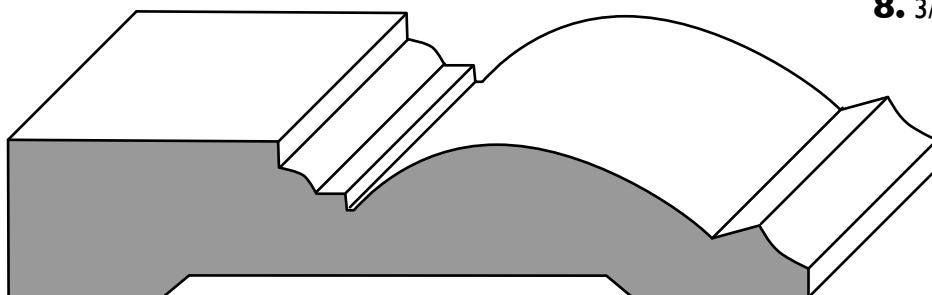

9. $3/4 \times 4$ "

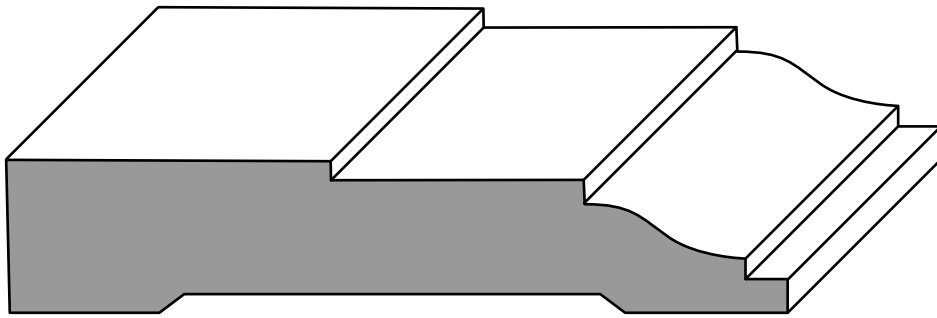

10. 3/4 x 4"

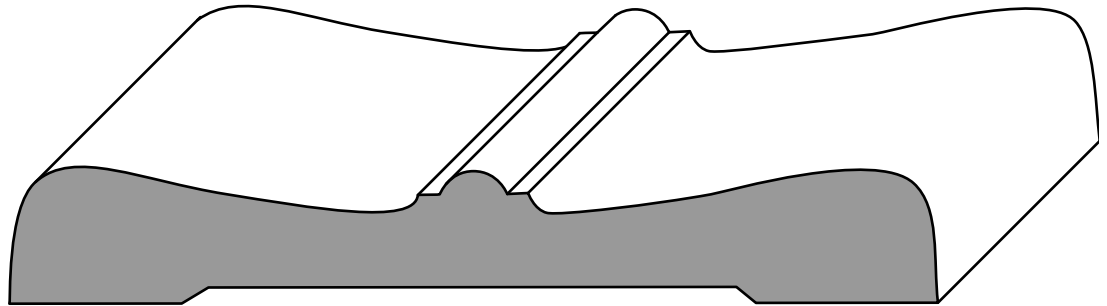

11. 11/16 x 4 13/16"

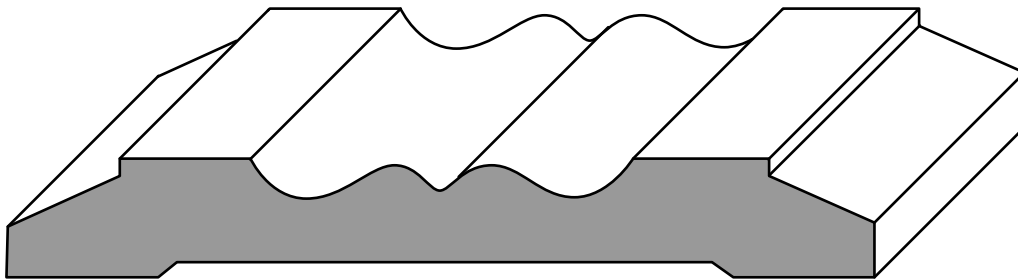

12. 11/16 x 4 1/2"

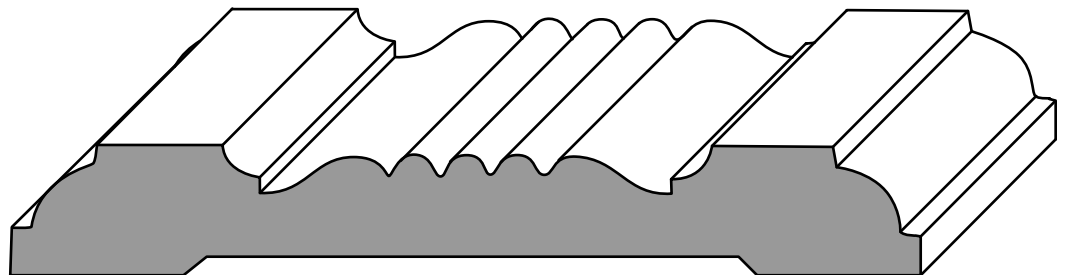

13. 11/16 x 4 3/4"

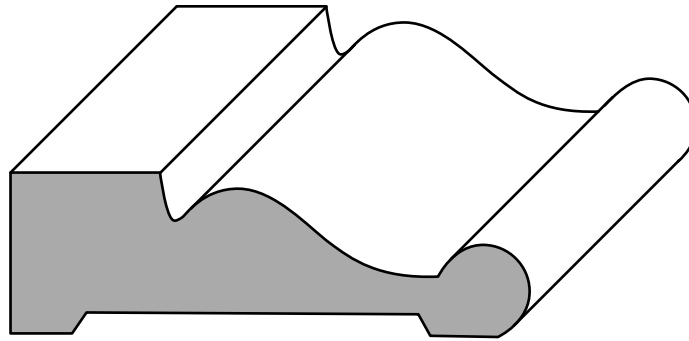

14. 7/8 x 2 3/4"

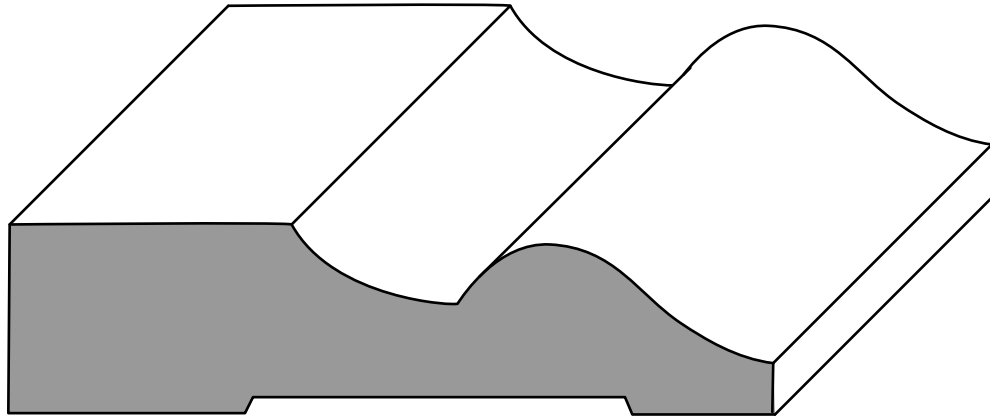

20. 1 x 4"

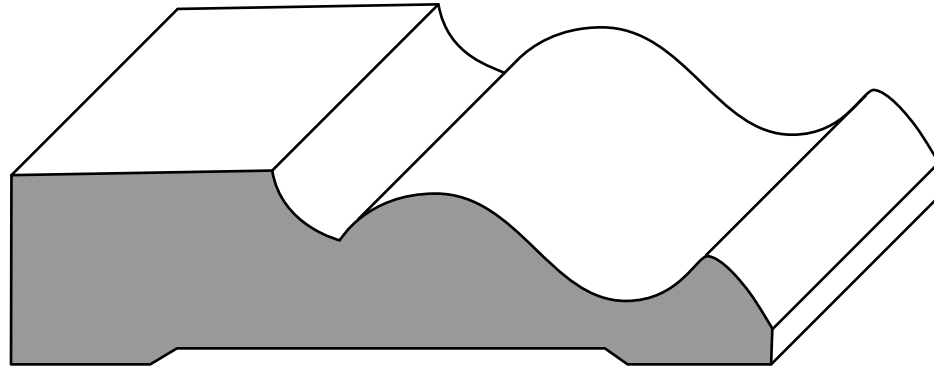

21. 1 x 4"

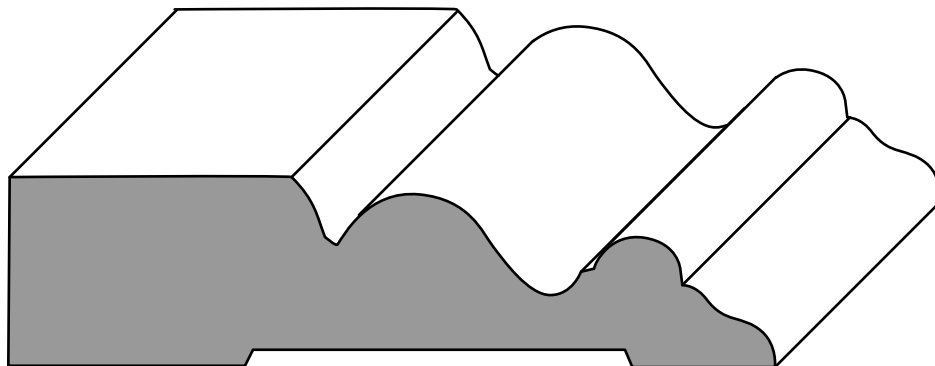

22. 1 x 4"

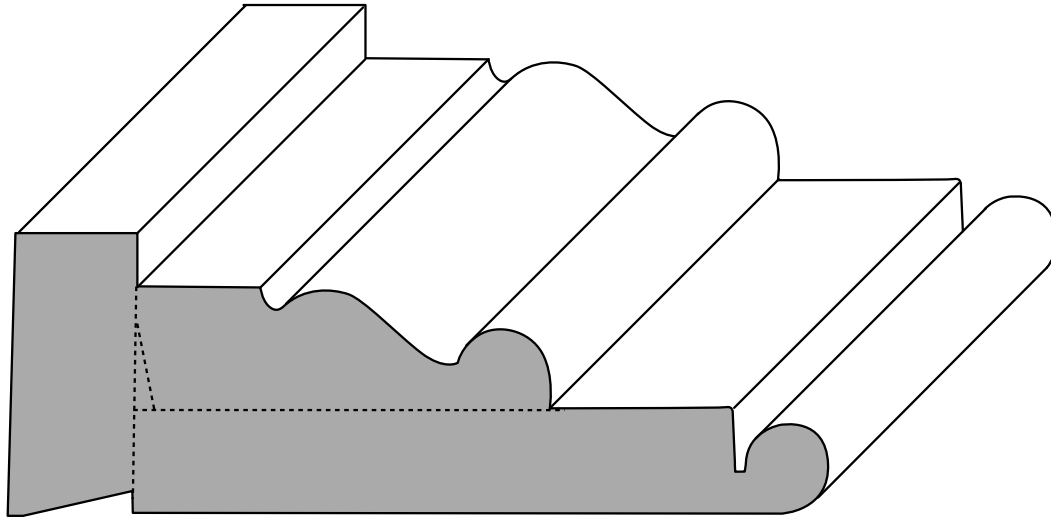

30. 1 1/2 x 4 1/4"

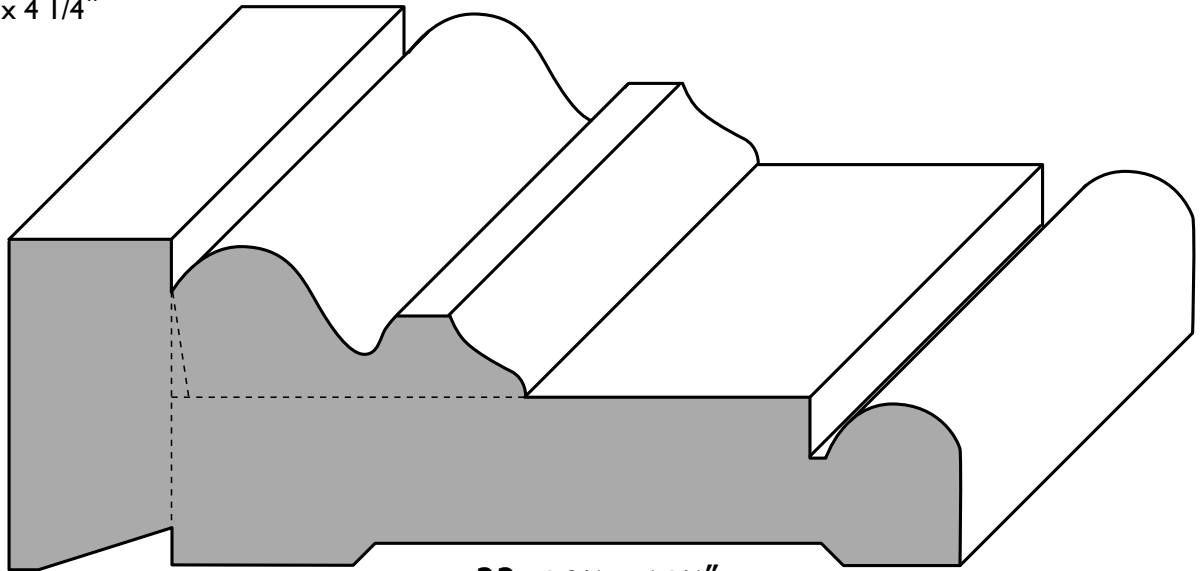

33. 1 3/4 x 4 1/4"

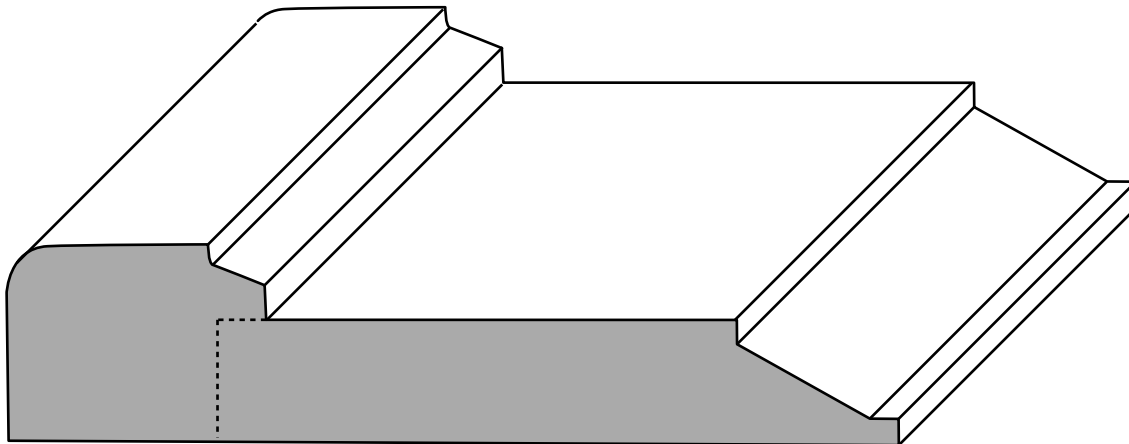

34. 1 x 4 7/16"

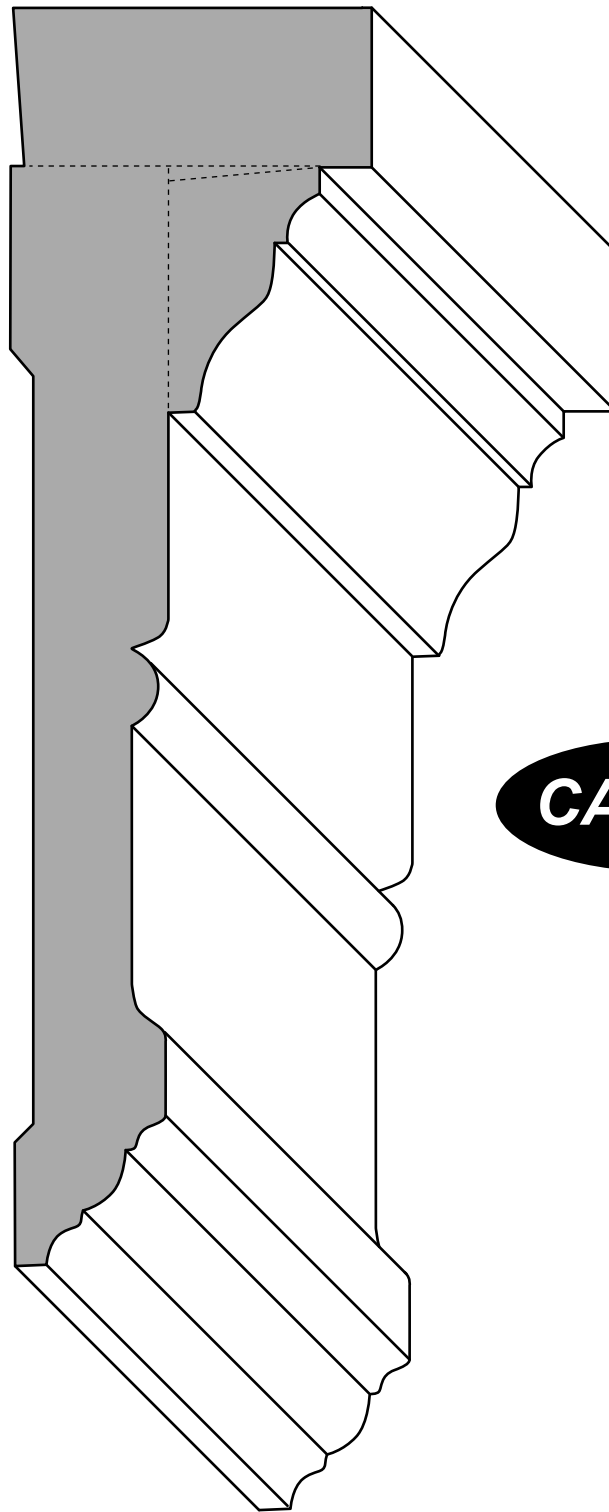

CASING

31. 1 7/8 x 6 1/2"

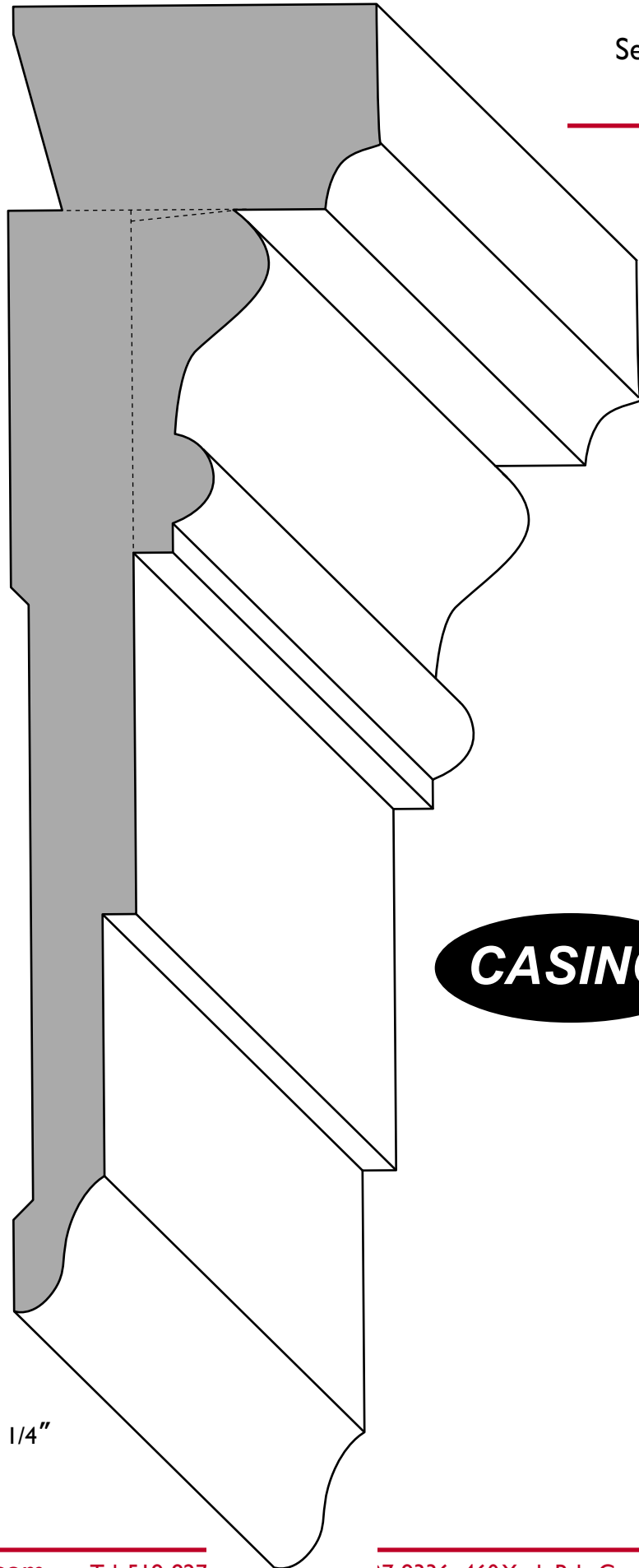

CASING

32. 2 3/8 x 8 1/4"